











## Panel



## Technical features

- Lower full metal drawer
- Upper liftable holder for linen bag incl polyester bag of 127 L

## Technical data

								
HALLEY 2	max 150 kg	2 front swivel x Ø150 mm and 2 rear fixed x Ø300 mm 'PNP'	Steel tubing structure with HPL panels	628 x 540 x h1433 mm	628 x 540 x h1433 mm	3 - 4	37 kg	050401HPL



## Technical draw

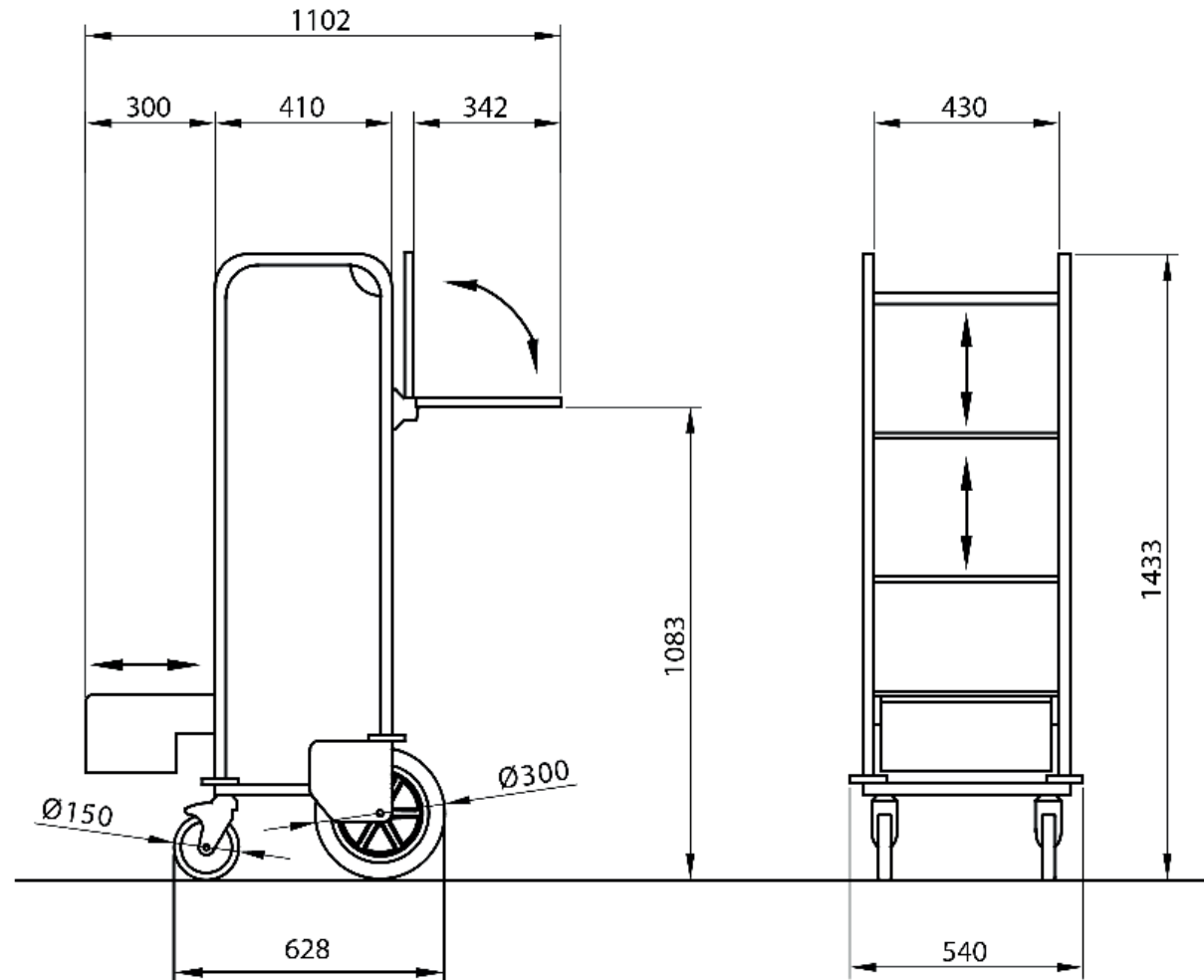



## Options



**Broom clip**

One broom clip, possibility to add more



**4 additional donut bumpers on each of the trolley's corner**

Soft, non-marking material  
Light-grey, RAL 9006



**Small items box, metal (without lid)**

Adjustable separators made of HPL  
(size S=1pc. / size M=2pcs. / size L=3pcs.), height 10 cm  
Pre-punched for mechanical fixing into trolley top



**Small items metal box with lid**

Adjustable separators made of HPL  
(size S=1pc. / size M=2pcs. / size L=3pcs.)  
Height 10cm  
Pre-punched for mechanical fixing into trolley top  
Handle with chrome finish, soft closing

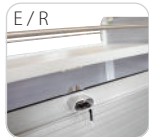

**Shutter lockable**

Upper snap closure, 2 keys



**Bucket holder, powder coated**

Lower, full steel base  
Dimensions: 354 x 566 mm  
2 buckets, 12 L each (red and blue)  
2 bumpers Ø100 mm



**Waste bag holder, powder coated**

Upper liftable holder  
Black plastic lid with Caddie logo  
Lower liftable base with metal bars and abrasion-proof, non-marking donut bumpers Ø100 mm



**Holders for waste sorting kit with 1 bag and mask bag**

Upper folding support  
Black plastic lid with Caddie logo  
Black polyester bag 127 L  
Lower folding support with metal bars e non-marking bumper wheels Ø100 mm



**Upgrade for 4 super elastic castors Ø200 mm, two of which with brake. Optional not compatible with RS5**

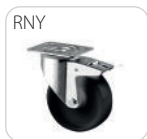

**Upgrade for 4 nylon swivel castors, and 2 with brake**

Ideal for carpeted floors  
Castor made of nylon Ø160 mm



**Compartment pocket**

2 bigger pockets (approx. 22 x 21cm)  
6 transparent pockets (approx. 14 x 21cm)  
Fixation to the upper holder by velcro loops and additional velcro strips on rear



**Tool box**

Handy tool box with grip  
Material: Polypropylene copolymer  
Dimensions: Height (with handle) 26 cm, Width 29 cm, length 33 cm; Single compartments 10 x 30 x 14 cm



**Vacuum cleaner clip**



**Waste bag holder for 2 bags, powder coated for Tahiti and Palacenet**

Upper liftable holder  
Black plastic lid with Caddie logo  
Folding lower support with metal bars and 2 rubber bands for fixation of the waste bag  
Bumpers Ø100 mm



**Holders for waste sorting kit with 2 bags and mask bag for Tahiti and Palacenet**

Upper liftable holder equipped for 2 bags  
Black plastic lid with Caddie logo  
Folding lower support with metal bars and 2 rubber bands for fixation of the waste bag  
Black laundry bag  
Bumpers Ø100 mm